

Article number: 2310307231ESD

Description: E+G Antistatic base for levelling elements  
LV.A-60-14-AS-M10x98-ESD-C

## Measures

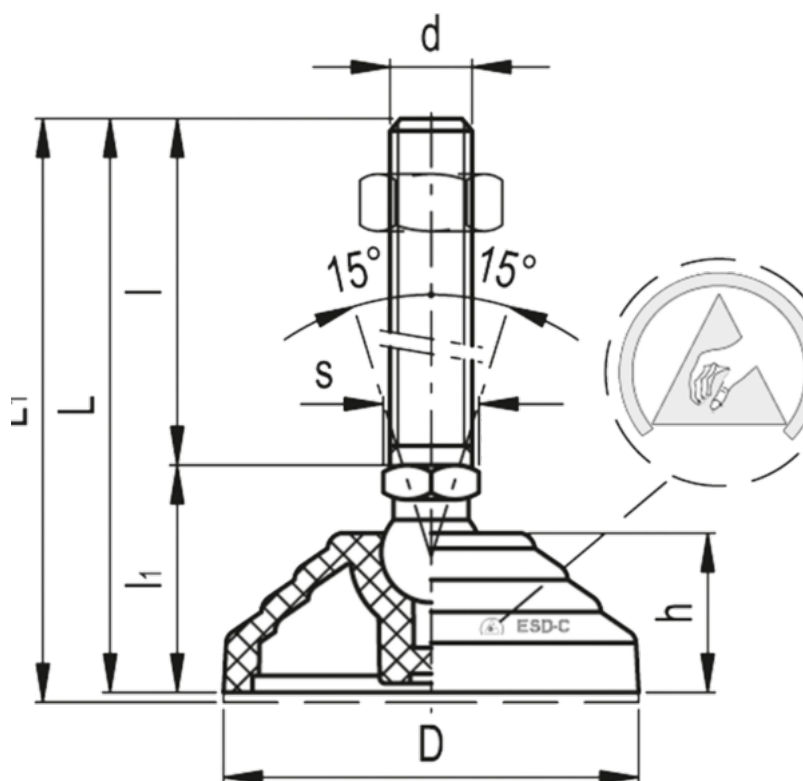

Articulation	= 14	Max load	= 14000
D	= 60	s	= 14
d	= M10	Weight in (g)	= 116
h	= 24		
l	= 98		
l1	= 33		
L	= 131		
L1	= 134		